

10kV Voltage transformer

型号含义/Model description

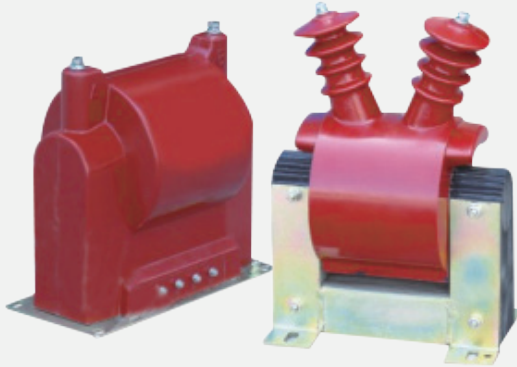

J D Z C 6、10

- 额定电压
Rated voltage (kV)
- 供操作电源使用
For operating power supply
- 浇注绝缘
Casting insulation
- 单相
Singlephase
- 电压互感器
Voltage transformer

技术参数/Technical data

型号 Type	额定电压比 Rated voltage ratio (V)	额定二次输出 Rated secondary output (VA)	极限输出 Max. output (VA)	额定绝缘水平 Rated insulation level (kV)
JDZC-6 JDZC-10	6000/100/220 10000/100/220	0.2/3---30/300	500	7.2/32/60 12/42/75
		0.5/3---50/300	700	
		0.2/3---30/400	800	
		0.5/3---50/400	1000	
		0.2/3---50/1500	3000	
		0.5/3---80/1500		

外形安装尺寸/Overall dimension drawing

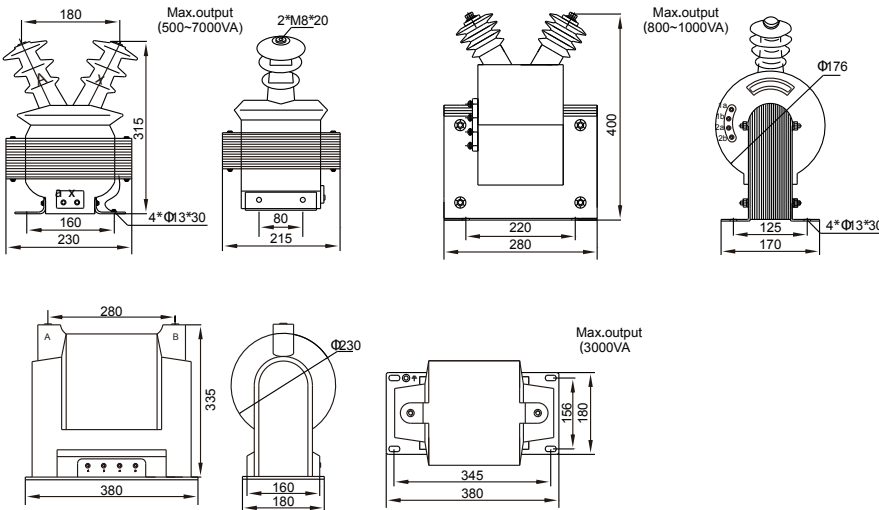

接线图/Wiring diagram

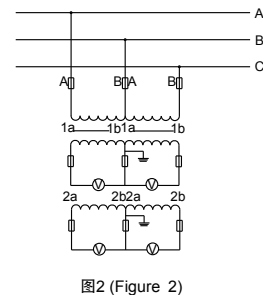
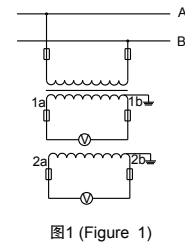

10kV Voltage transformer



型号含义/Model description

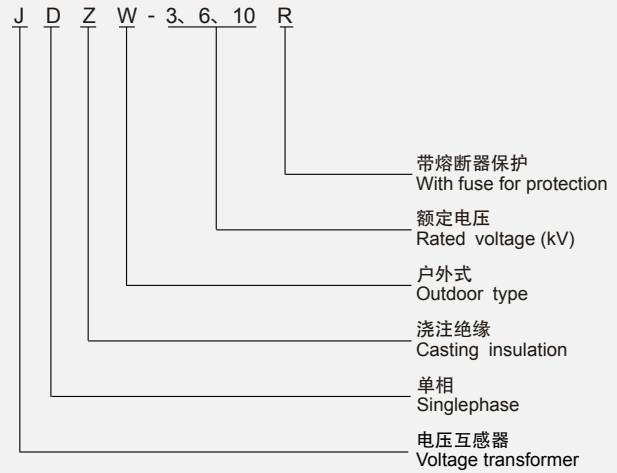

技术参数/Technical data

型号 Type	额定电压比 Rated voltage ratio (V)	额定二次输出 Rated secondary output (VA)							极限输出 Max. output (VA)	额定绝缘水平 Rated insulation level (kV)	接线图 Wiring diagram
		0.2	0.5	1	3	0.2/0.2 0.2/0.5	0.5/0.5	6P(3P)			
JDZW-3R	3000/100										
JDZW-6R	6000/100	30	50	100	200	/	/	/	500	7.2/32/60	1- 2 Figure 1-2
	10000/100										
JDZW-10R	10000/220									12/42/75	3- 4 Figure 3-4
	10000/100/100	/	/	/	/	15/15 15/20	30/30	/	300/300		
	10000/100/220	/	/	/	/	0.2/3-25/500 0.5/3-50/500			300/500		

外形安装尺寸/Overall dimension drawing

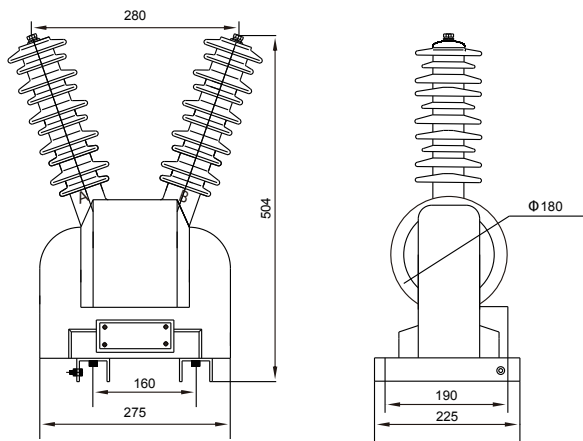

接线图/Wiring diagram

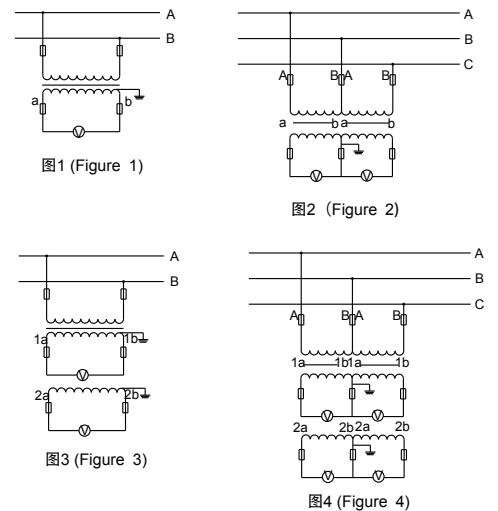

10kV Voltage transformer

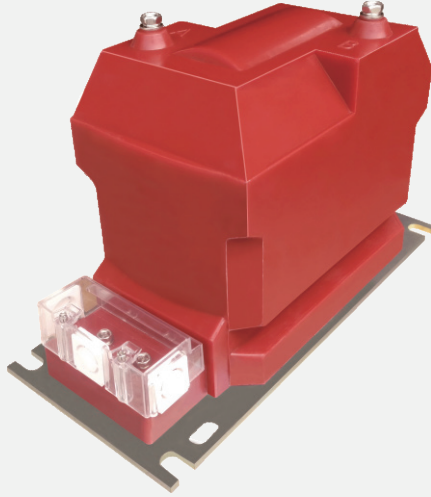

型号含义/Model description

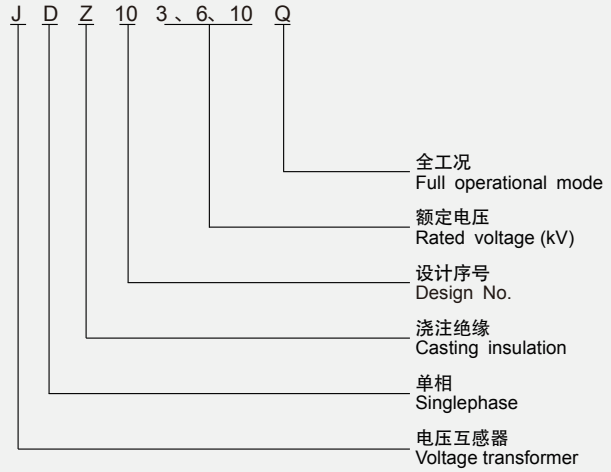

技术参数/Technical data

额定电压比 Rated voltage ratio (V)	额定二次输出 Rated secondary output (VA)				极限输出 Max. output (VA)	额定绝缘水平 Rated insulation level (kV)	备注 Notes	接线图 Wiring diagram
	0.2	0.5	1	3				
3000/100						3.6/25/40	等同 "RZL" Same as "RZL"	1 2 Figure 12
6000/100	15	30	60	150	200	7.2/32/60		
10000/100						12/42/75		

外形安装尺寸/Overall dimension drawing

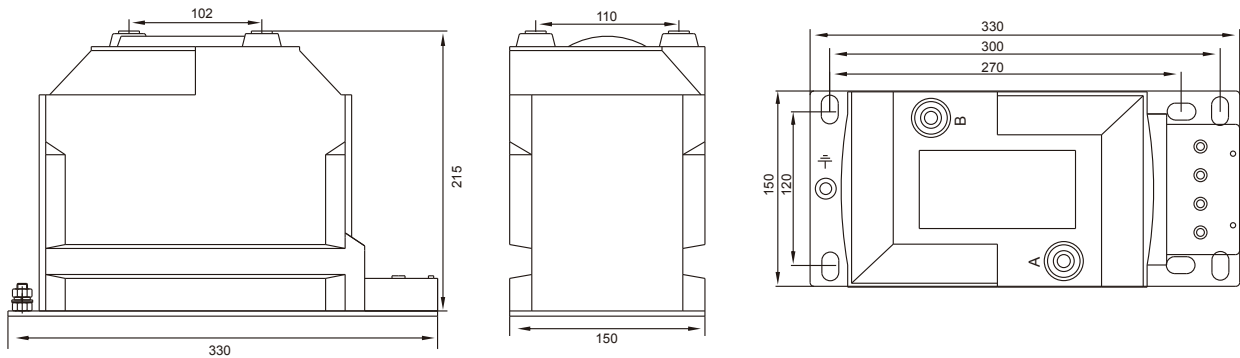

接线图/Wiring diagram

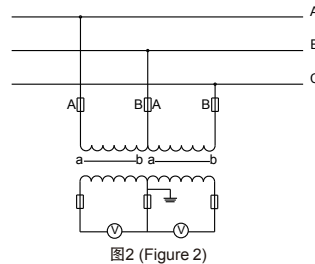
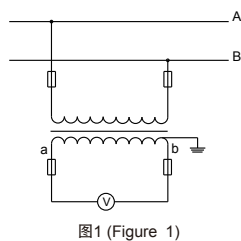

10kV Voltage transformer

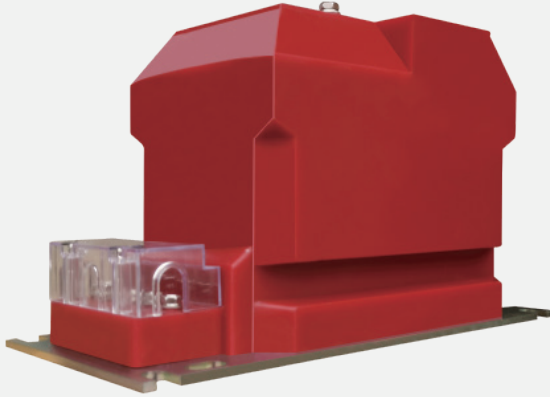

型号含义/Model description

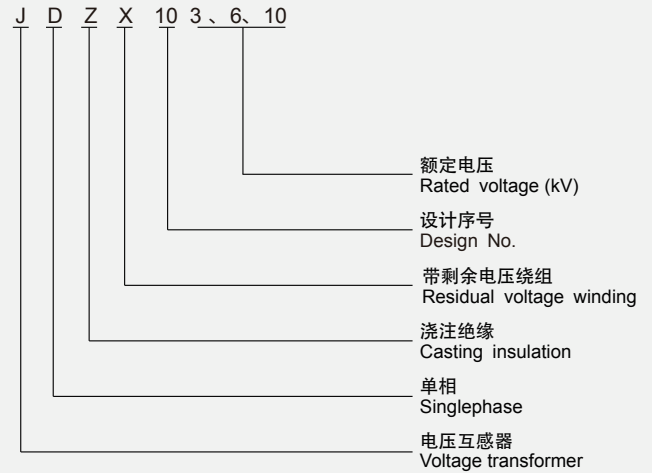

技术参数/Technical date

额定电压比 Rated voltage ratio (V)	额定二次输出 Rated secondary output (VA)					极限输出 Max. output (VA)	额定绝缘水平 Rated insulation level (kV)	备注 Notes
	0.2	0.5	1	3	6P(3P)			
$\frac{3000}{\sqrt{3}} / \frac{100}{\sqrt{3}} / \frac{100}{3}$	15	30	60	150	50	200	3.6/25/40	等同 "RZL" Same as "RZL"
$\frac{6000}{\sqrt{3}} / \frac{100}{\sqrt{3}} / \frac{100}{3}$								
$\frac{10000}{\sqrt{3}} / \frac{100}{\sqrt{3}} / \frac{100}{3}$								

外形安装尺寸/Overall dimension drawing

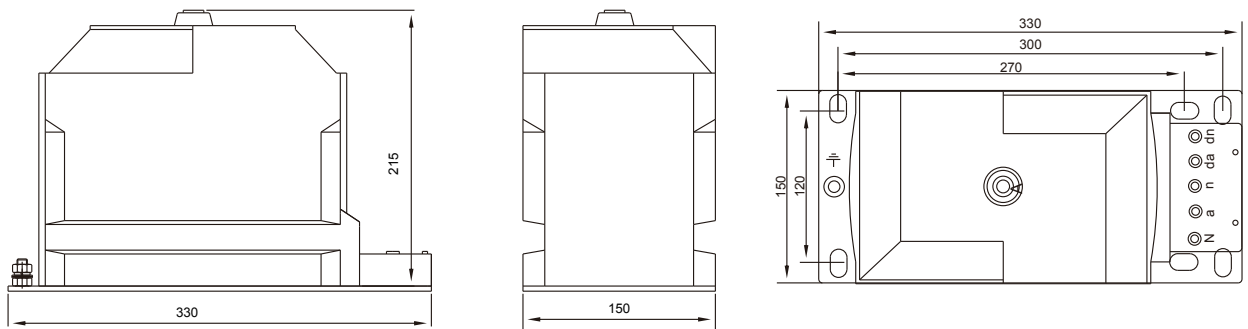

接线图/Wiring diagram

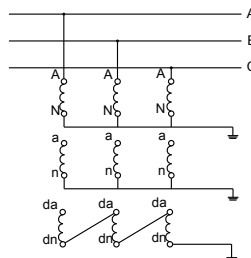

10kV Voltage transformer



型号含义/Model description

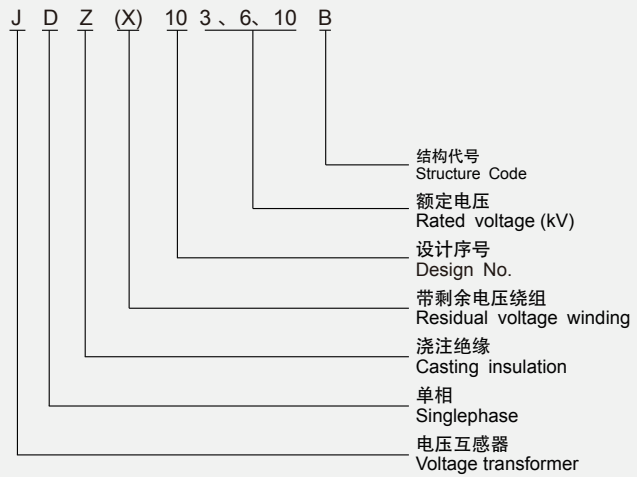

技术参数/Technical data

型号 Type	额定电压比 Rated voltage ratio (V)	额定二次输出 Rated secondary output (VA)							极限输出 Max. output (VA)	额定绝缘水平 Rated insulation level (kV)	备注 Notes	接线图 Wiring diagram
		0.2	0.5	1	3	0.2/0.2 0.2/0.5	0.5/0.5	6P(3P)				
JDZ10 3A1	3000/100								300	3.6/25/40	等同 "RZL" Same as "RZL"	图1 图2 Figure2
JDZ10 6A1	6000/100	30	50	100	200	/	/	/		7.2/32/60		
JDZ10 10A1	10000/100									12/42/75		图3 图4 Figure 3 4
JDZ10 10A1	10000/100/100	/	/	/	/	10/10 10/15	15/15	200/200	50	3.6/25/40	/	图5 Figure 5
JDZX10 3A1	$\frac{3000/100/100}{\sqrt{3}/\sqrt{3}/3}$	30	50	100	200	/	/	300		7.2/32/60		
JDZX10 6A1	$\frac{6000/100/100}{\sqrt{3}/\sqrt{3}/3}$									12/42/75		
JDZX10 10A1	$\frac{10000/100/100}{\sqrt{3}/\sqrt{3}/3}$									200/200		
JDZX10 10A1	$\frac{10000/100/100/100}{\sqrt{3}/\sqrt{3}/\sqrt{3}/3}$	/	/	/	/	10/10 10/15	15/15	200/200	12/42/75	图6 Figure 6		

外形安装尺寸/Overall dimension drawing

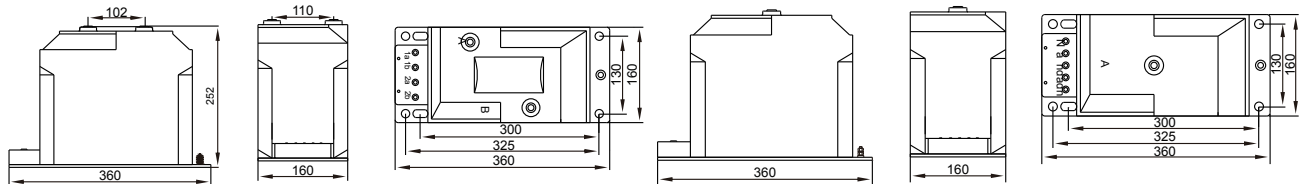

接线图/Wiring diagram

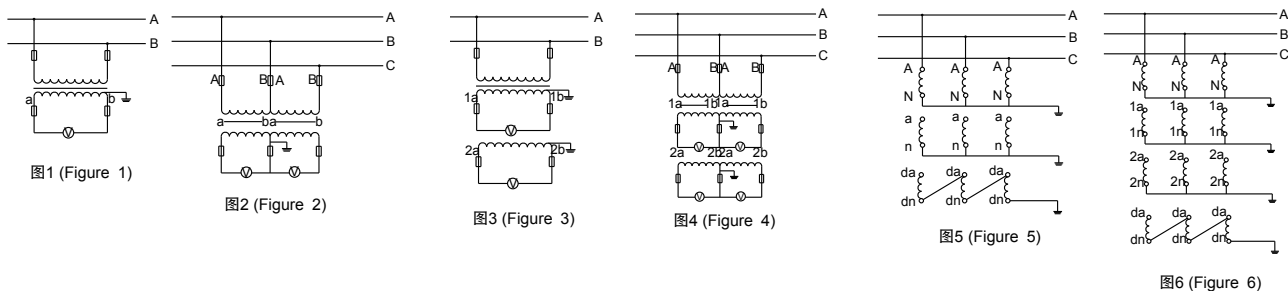

10kV Voltage transformer

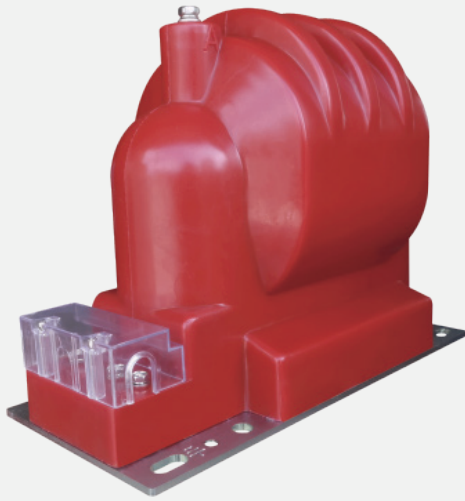

型号含义/Model description

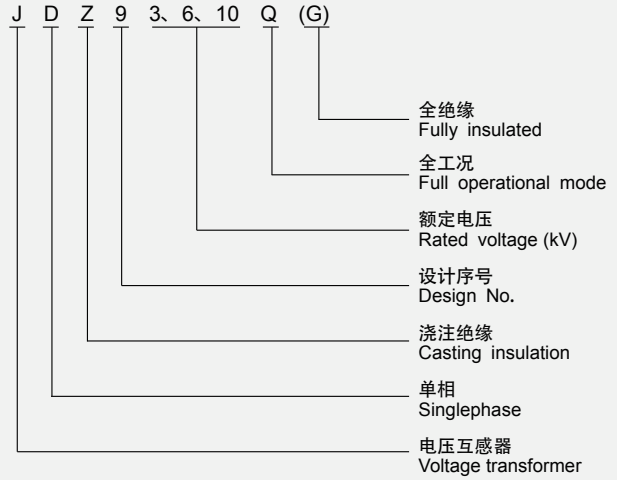

技术参数/Technical data

型号 Type	额定电压比 Rated voltage ratio (V)	额定二次输出 Rated secondary output (VA)							极限输出 Max. output (VA)	额定绝缘水平 Rated insulation level (kV)	备注 Notes	接线图 Wiring diagram
		0.2	0.5	1	3	0.2/0.2 0.2/0.5	0.5/0.5	6P(3P)				
JDZ9-3Q	3000/100									3/6/25/40		
JDZ9-6Q	6000/100	40	100	200	240	/	/	/	500	7.2/32/60	等同 "VKV" Same as "VKV"	图1 图2 Figure 12
JDZ9-10Q	10000/100									12/42/75		
JDZ9-10Q	10000/100/100	/	/	/	/	20/20 20/30	30/30		400/400			图3 图4 Figure 34
JDZX9-3G	$\frac{3000/100/100}{\sqrt{3}/\sqrt{3}/3}$									3.6/25/40	/	图5 Figure 5
JDZX9-6G	$\frac{6000/100/100}{\sqrt{3}/\sqrt{3}/3}$	30	60	180	500	/	/	100	600	7.2/32/60		
JDZX9-10G	$\frac{10000/100/100}{\sqrt{3}/\sqrt{3}/3}$									12/42/75		
JDZX9-10G	$\frac{10000/100/100/100}{\sqrt{3}/\sqrt{3}/\sqrt{3}/3}$	/	/	/	/	15/15 15/20	40/40		400/400			图6 Figure 6

外形安装尺寸/Overall dimension drawing

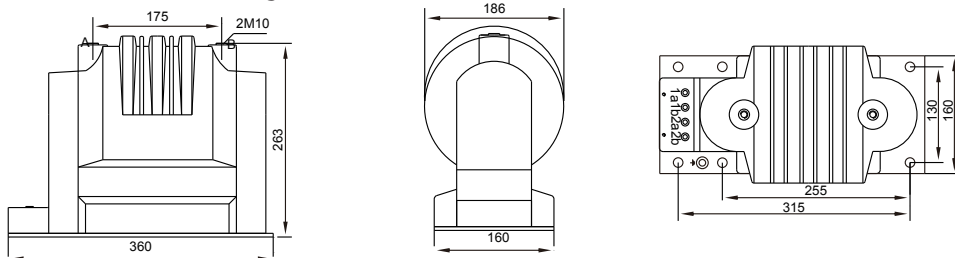

接线图/Wiring diagram



图1 (Figure 1)



图2 (Figure 2)

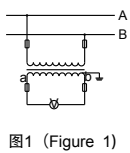

图3 (Figure 3)

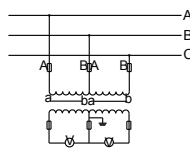

图4 (Figure 4)

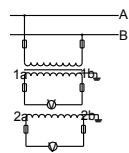

图5 (Figure 5)

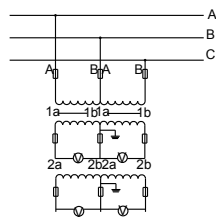

图6 (Figure 6)

10kV Voltage transformer

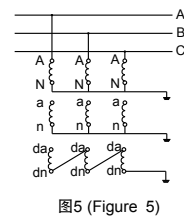

型号含义/Model description

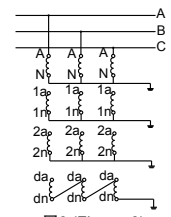
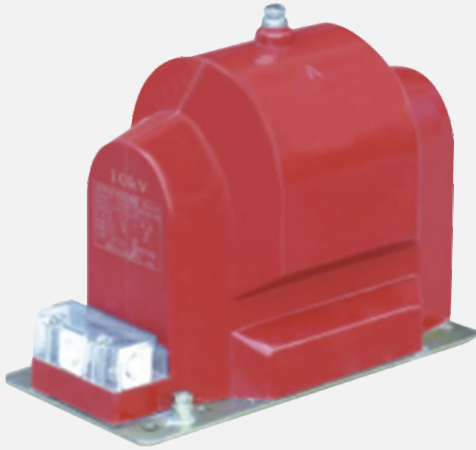
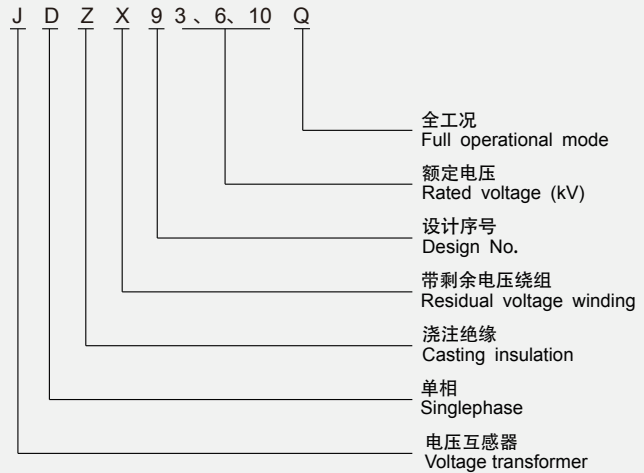

技术参数/Technical data

额定电压比 Rated voltage ratio (V)	额定二次输出 Rated secondary output (VA)						极限输出 Max. output (VA)	额定绝缘水平 Rated insulation level (kV)	备注 Notes	接线图 Wiring diagram	
	0.2	0.5	1	3	0.2/0.2 0.2/0.5	0.5/0.5 6P(3P)					
$\frac{3000/100/100}{\sqrt{3} \sqrt{3} / 3}$	30	60	180	500	/	/	100	600	3.6/25/40	等同 "VKI" Same as "VKI"	图 5 Figure 5
$\frac{6000/100/100}{\sqrt{3} \sqrt{3} / 3}$											
$\frac{10000/100/100}{\sqrt{3} \sqrt{3} / 3}$											
$\frac{10000/100/100/100}{\sqrt{3} \sqrt{3} \sqrt{3} / 3}$	/	/	/	/	15/15 15/20	40/40	400/400	12/42/75		图 6 Figure 6	

外形安装尺寸/Overall dimension drawing

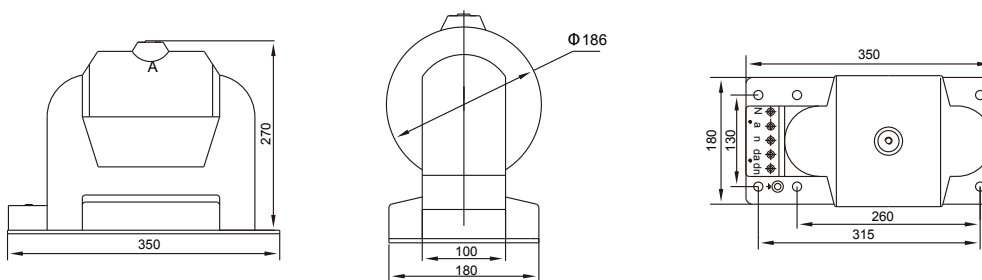

接线图/Wiring diagram

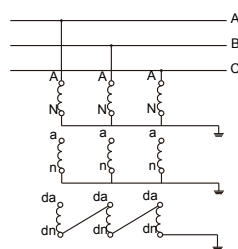

图1 (Figure 1)

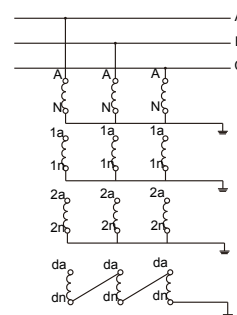

图2 (Figure 2)